



RIMiT[®] series



stand

NEW

RIMiT[®] stand

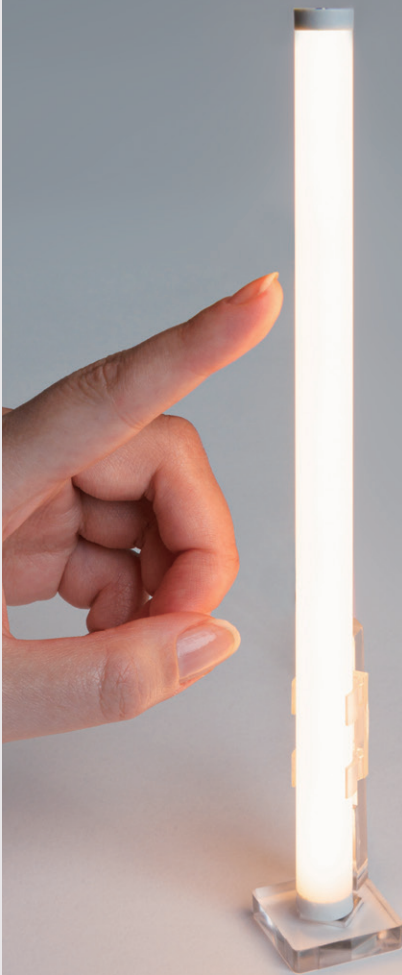

Light stand for RIMiT series

Application & Recommended point

As corner lights for a showcase

Center-concentrated illumination inside the showcase enhances the appeal of products on display.

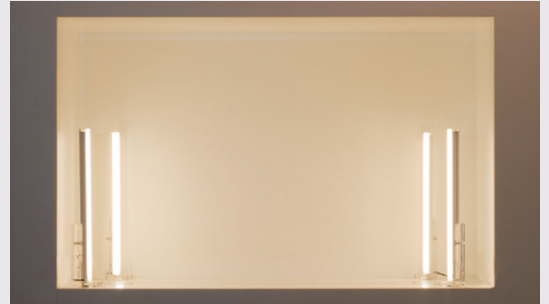

As a bedside reading light

Glare-free, dotless lighting that delivers optimal brightness.



Elevate the elegance with the RIMiT series luminaire

Made from high-transparency acrylic, the RIMiT Stand allows light to spread unobstructed. Compatible with fixtures up to 410mm, it effortlessly transforms into a stylish stand lamp.

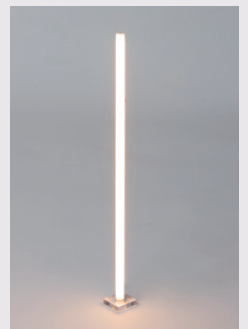

A variety of 7 types of fixtures x 6 different light source colors



RIMiT stand

Model No.: LRM-PT-M

Compatible RIMiT fixtures Top views of RIMiT stand with luminaires (S=1:2)

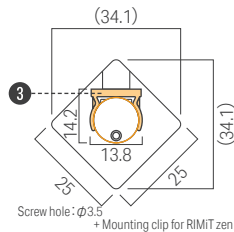
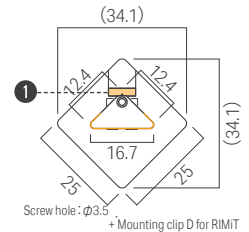
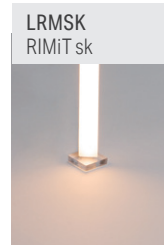
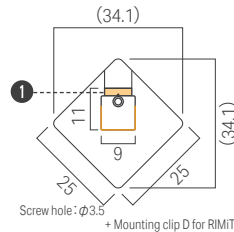
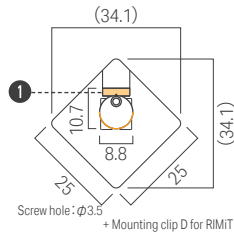
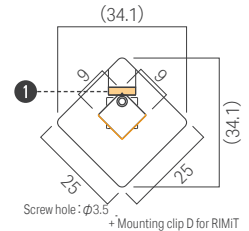
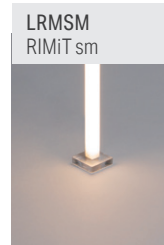
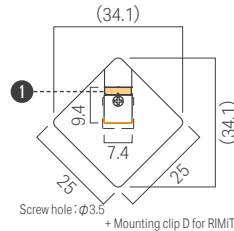
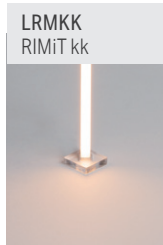
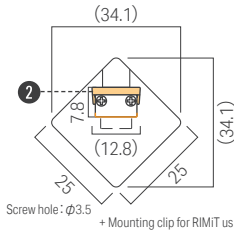
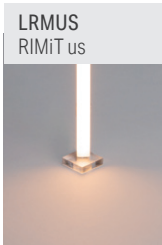

It is recommended that RIMiT Series lighting fixtures with RIMiT Stand, be configured with a one-end, open-ended lead wire of at least 1 meter to facilitate easier wiring installation.

Stand_External dimension

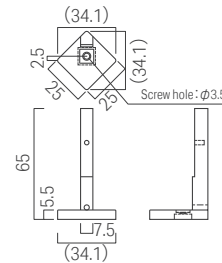

Compatible clips



1 Mounting clip D for RIMiT
Model No.: LRM-PT-D
5 pcs/1 bag



2 Mounting clip for RIMiT us
Model No.: LRMUS-PT-A
5 pcs/1 bag



3 Mounting clip for RIMiT zen
Model No.: LRMZE-PT-L
5 pcs/1 bag

Installation instructions for RIMiT stand

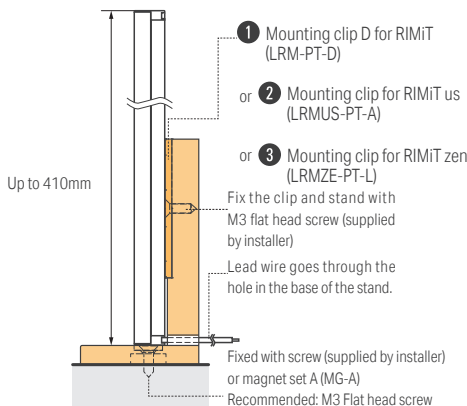

Magnet mounting available

4 Magnet Set A
Model No.: MG-A
To fix the stand on metal plate (supplied by installer) with the magnet

- The maximum length of fixture that can be used with a stand is 410mm.
- Make sure to use M3 flat head screws or magnet sets (MG-A) to secure the fixture in place.
- Securely fasten the stand to a sturdy surface using screws or magnets. Incomplete fixation can cause the fixture to tip over, posing a risk of injury.
- Ensure that the luminaire, clip and stand are secured.