

silux series

Luci silux wide K(13.3W/m)

Luci silux wide K(13.3W/m) 74



Luci Pte. Ltd.

2020.04.10

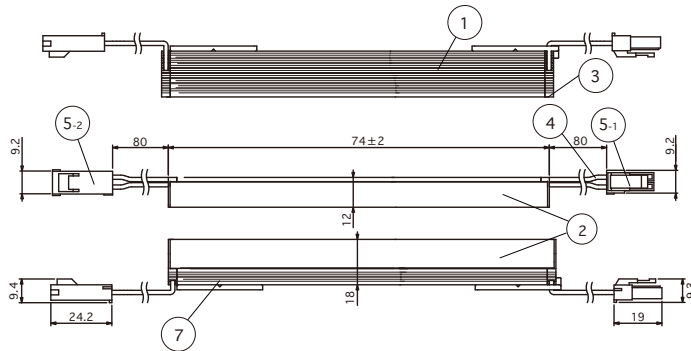

Side View

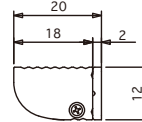

-Multiclip K Mounted (downward lighting)

Installation Dimensions (Side View)

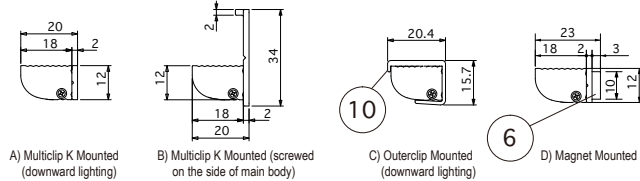

Accessories • Option parts :  
Multiclip K for silux (LSX-PTM-C) (3 or 5pcs / 1bag)

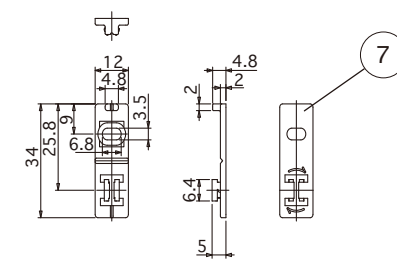

Option parts : Outerclip for silux wide (LSXW-PT-A) (5pcs / 1bag)

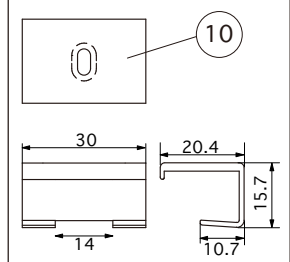

Option parts :  
Power supply cable 3000mm for SL connector (CAD-3000-MCRN-I)

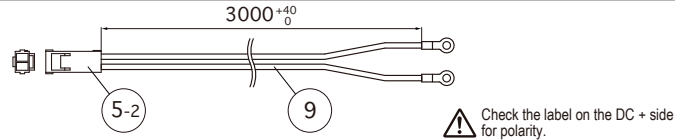

Option parts :  
Joint cable 1000mm for SL connector (CAD-1000-MCFC-I)

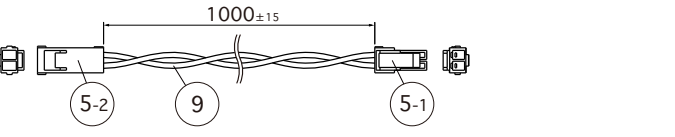

Option parts :  
Liftclip for silux (LSX-PTL) (2pcs / 1bag)

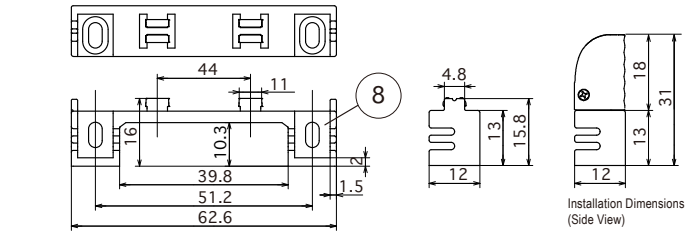

Spec • Rating may be subject to change without announcements

Unit Of Measure : mm

Part Name	Material	Note
1 Body	Aluminum, alumite treatment	White
2 Body Cover	Polycarbonate	Diffuser
3 Side cover	Polycarbonate	Diffuser
4 Lead wire		UL1007 AWG22, black+, white-
5 Connector	Nylon	5-1:SLP-02V(JST) White 5-2:SLR-02VF(JST) White
6 Magnet	Neodymium magnet	Silver
7 Mounting Clip	Polycarbonate	Clear
8 Mounting Clip (Lift clip)	Polycarbonate	Clear
9 Lead wire		UL1007 AWG20
10 Mounting Clip (Outer clip)	Polycarbonate	Clear

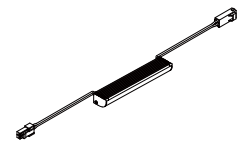

Spec	Input voltage : DC24V	Weight : 17g
Power consumption : 0.7W	Number of LEDs : 14	
Max. sets connectable : 6m		
Environment : Indoors (No Condensation)		
Operating temperature : 0°C~+35°C (No Condensation)		
Accessories : Multiclip K (3pcs / 1 bag)		
Option parts : Power supply cable 3000mm,		
Joint cable 1000mm,		
Multiclip K (3pcs / 1 bag)		
Liftclip (2pcs / 1 bag)		
Outerclip (5pcs / 1 bag)		
Magnet attachment		

Light Source color :
Natural white : N : 5000K (50 lm* / Ra 93)
White : W : 4000K (50 lm* / Ra 94)
Warm white 3500K: WW : 3500K (48 lm* / Ra 94)
Warm white 3000K : L30 : 3000K (47 lm* / Ra 93)
Warm white 2700K : L27 : 2700K (45 lm* / Ra 93)
Warm white 2400K : L24 : 2400K (42 lm* / Ra 94)
*=Equivalent

Item Number
LSXWK-0074-N-DF-I-13
LSXWK-0074-W-DF-I-13
LSXWK-0074-WW-DF-I-13
LSXWK-0074-L30-DF-I-13
LSXWK-0074-L27-DF-I-13
LSXWK-0074-L24-DF-I-13

Job/Project Name	Area/Location/Circuit No.
Product Code	Qty. Length(mm)

**silux series**

**Luci silux wide K(13.3W/m)**

Luci silux wide K(13.3W/m) 259



**Luci Pte. Ltd.**

2020.04.10

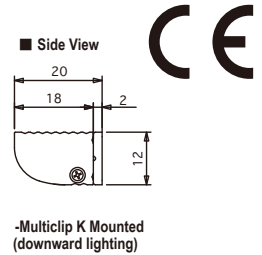
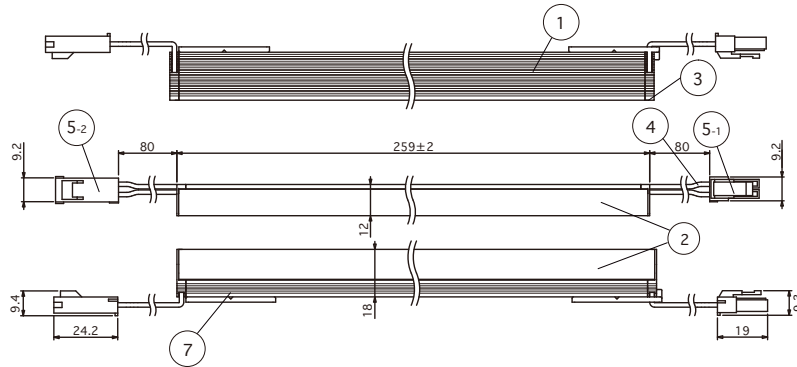

**Installation Dimensions (Side View)**

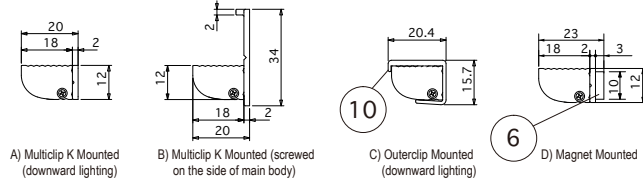

**Accessories • Option parts :**  
Multiclip K for silux (LSX-PTM-C) (3 or 5pcs / 1bag)

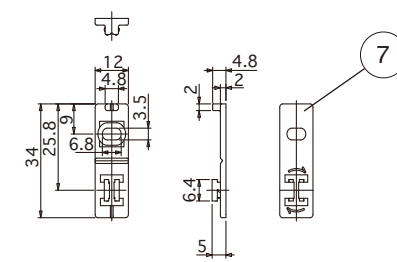

**Option parts : Outerclip for silux wide (LSXW-PT-A) (5pcs / 1bag)**

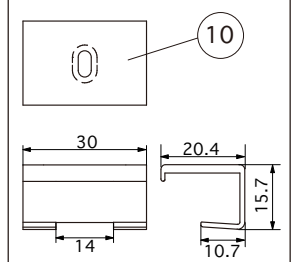

**Option parts :**  
Power supply cable 3000mm for SL connector (CAD-3000-MCRN-I)

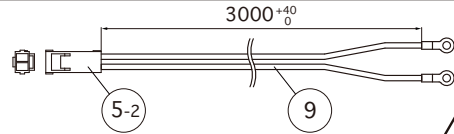

⚠ Check the label on the DC + side for polarity.

**Option parts :**  
Joint cable 1000mm for SL connector (CAD-1000-MCFC-I)

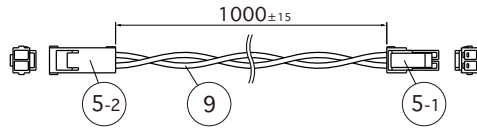

**Option parts :**  
Liftclip for silux (LSX-PTL) (2pcs / 1bag)

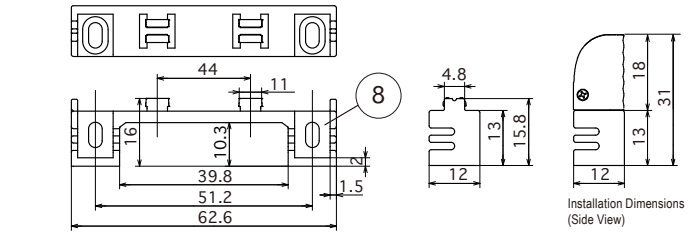

Spec · Rating may be subject to change without announcements

Unit Of Measure : mm

Part Name	Material	Note
1 Body	Aluminum, alumite treatment	White
2 Body Cover	Polycarbonate	Diffuser
3 Side cover	Polycarbonate	Diffuser
4 Lead wire		UL1007 AWG22, black+, white-
5 Connector	Nylon	5-1:SLP-02V(JST) White 5-2:SLR-02VF(JST) White
6 Magnet	Neodymium magnet	Silver
7 Mounting Clip	Polycarbonate	Clear
8 Mounting Clip (Lift clip)	Polycarbonate	Clear
9 Lead wire		UL1007 AWG20
10 Mounting Clip (Outer clip)	Polycarbonate	Clear

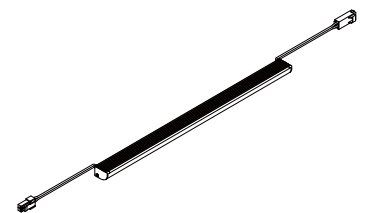

Spec	Input voltage : DC24V	Weight : 47g
Power consumption : 3.3W	Number of LEDs : 49	
Max. sets connectable : 6m		
Environment : Indoors (No Condensation)		
Operating temperature : 0°C~+35°C (No Condensation)		
Accessories : Multiclip K (3pcs / 1 bag)		
Option parts : Power supply cable 3000mm,		
Joint cable 1000mm,		
Multiclip K (3pcs / 1 bag)		
Liftclip (2pcs / 1 bag)		
Outerclip (5pcs / 1 bag)		
Magnet attachment		

Light Source color :	Item Number
Natural white : N : 5000K (202 lm* / Ra 93)	LSXWK-0259-N-DF-I-13
White : W : 4000K (202 lm* / Ra 94)	LSXWK-0259-W-DF-I-13
Warm white 3500K: WW : 3500K (194 lm* / Ra 94)	LSXWK-0259-WW-DF-I-13
Warm white 3000K: L30 : 3000K (189 lm* / Ra 93)	LSXWK-0259-L30-DF-I-13
Warm white 2700K: L27 : 2700K (181 lm / Ra 93)	LSXWK-0259-L27-DF-I-13
Warm white 2400K: L24 : 2400K (168 lm* / Ra 94)	LSXWK-0259-L24-DF-I-13
*=Equivalent	

Job/Project Name	Area/Location/Circuit No.
Product Code	Qty. Length(mm)

silux series

Luci silux wide K(13.3W/m)

Luci silux wide K(13.3W/m) 388



Luci Pte. Ltd.

2020.04.10

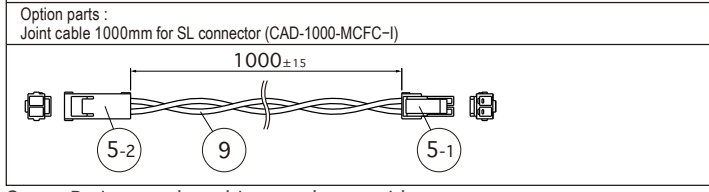
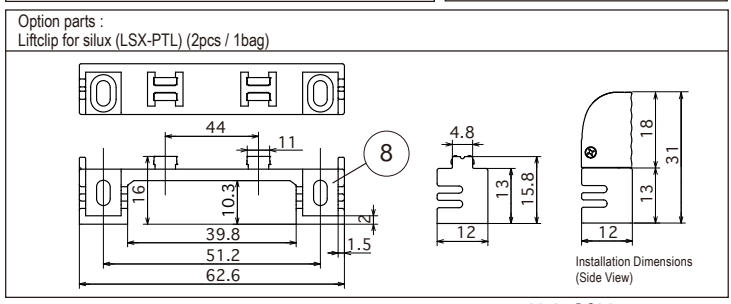
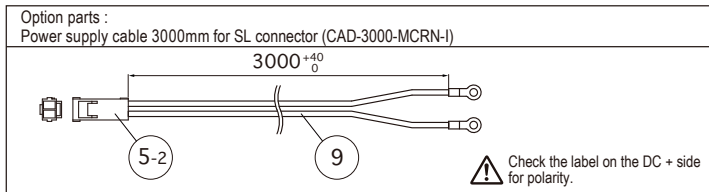
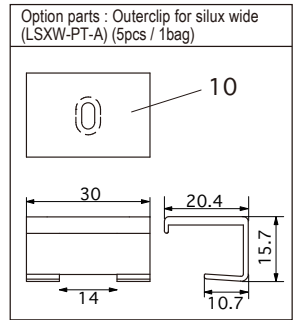
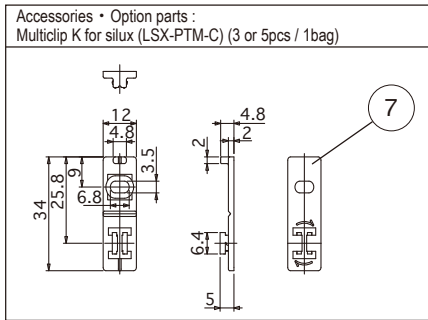
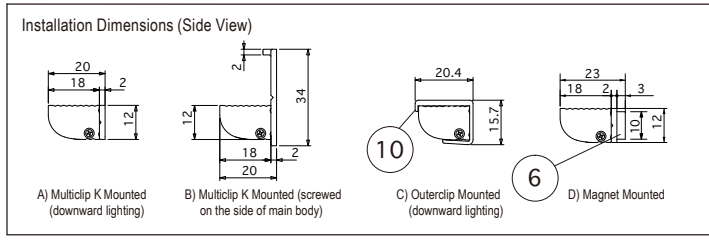
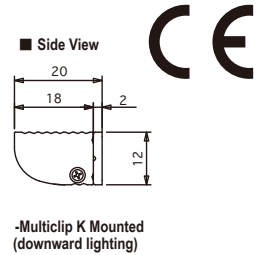
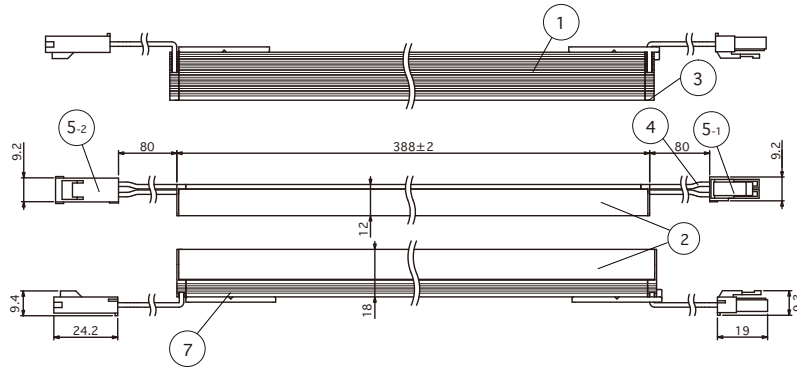

Spec · Rating may be subject to change without announcements Unit Of Measure : mm

Part Name	Material	Note
1 Body	Aluminum, alumite treatment	White
2 Body Cover	Polycarbonate	Diffuser
3 Side cover	Polycarbonate	Diffuser
4 Lead wire		UL1007 AWG22, black+, white-
5 Connector	Nylon	5-1:SLP-02V(JST) White 5-2:SLR-02VF(JST) White
6 Magnet	Neodymium magnet	Silver
7 Mounting Clip	Polycarbonate	Clear
8 Mounting Clip (Lift clip)	Polycarbonate	Clear
9 Lead wire		UL1007 AWG20
10 Mounting Clip (Outer clip)	Polycarbonate	Clear

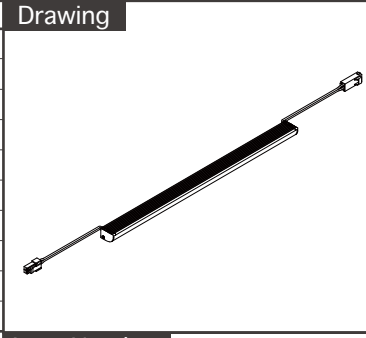

Spec	Item Number
Input voltage : DC24V Weight : 69g	LSXWK-0388-N-DF-I-13 LSXWK-0388-W-DF-I-13 LSXWK-0388-WW-DF-I-13 LSXWK-0388-L30-DF-I-13 LSXWK-0388-L27-DF-I-13 LSXWK-0388-L24-DF-I-13
Power consumption : 5.2W Number of LEDs : 77	
Max. sets connectable : 6m	
Environment : Indoors (No Condensation)	
Operating temperature : 0°C~+35°C (No Condensation)	
Accessories : Multiclip K (3pcs / 1 bag)	
Option parts : Power supply cable 3000mm,	
Joint cable 1000mm,	
Multiclip K (3pcs / 1 bag)	
Liftclip (2pcs / 1 bag)	
Outerclip (5pcs / 1 bag)	
Magnet attachment	
Light Source color :	Natural white : N : 5000K (304 lm* / Ra 93) White : W : 4000K (304 lm* / Ra 94) Warm white 3500K: WW : 3500K (291 lm* / Ra 94) Warm white 3000K : L30 : 3000K (284 lm* / Ra 93) Warm white 2700K : L27 : 2700K (272 lm / Ra 93) Warm white 2400K : L24 : 2400K (252 lm* / Ra 94)
	*=Equivalent

Job/Project Name \_\_\_\_\_ Area/Location/Circuit No. \_\_\_\_\_

Product Code \_\_\_\_\_ Qty. \_\_\_\_\_ Length(mm) \_\_\_\_\_

silux series

Luci silux wide K(13.3W/m)

Luci silux wide K(13.3W/m) 509



Luci Pte. Ltd.

2020.04.10

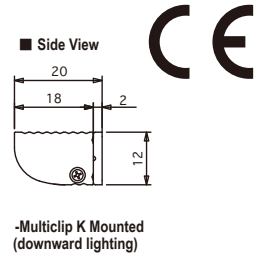
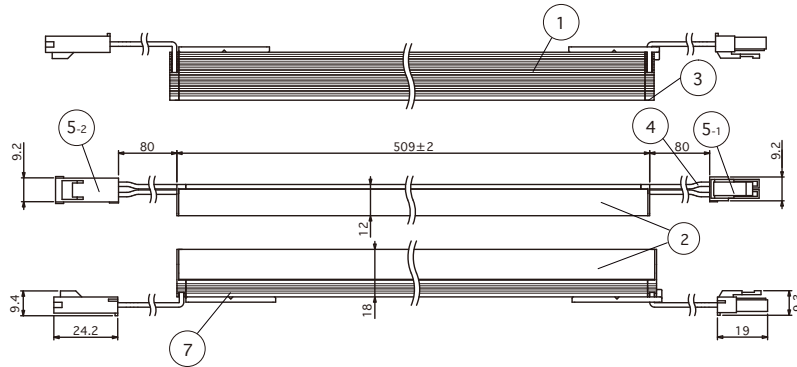

Installation Dimensions (Side View)

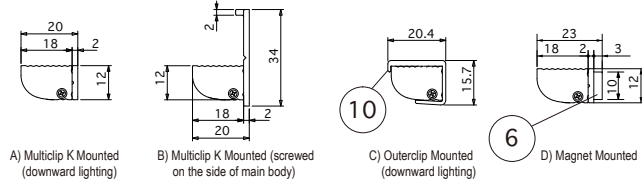

Accessories • Option parts :  
Multiclip K for silux (LSX-PTM-C) (3 or 5pcs / 1bag)

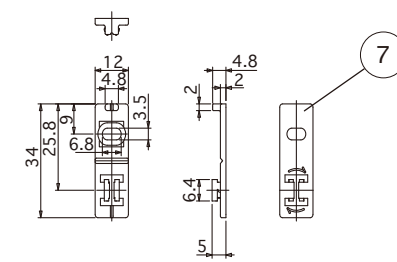

Option parts : Outerclip for silux wide (LSXW-PT-A) (5pcs / 1bag)

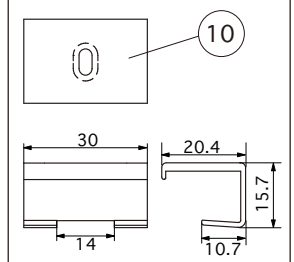

Option parts :  
Power supply cable 3000mm for SL connector (CAD-3000-MCRN-I)

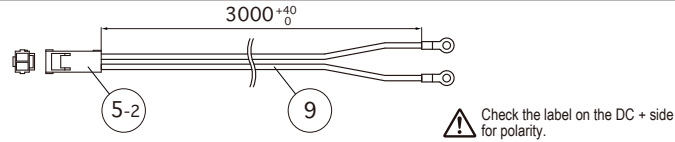

Option parts :  
Joint cable 1000mm for SL connector (CAD-1000-MCFC-I)

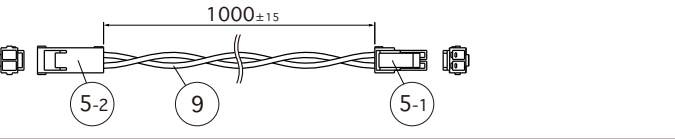

Option parts :  
Liftclip for silux (LSX-PTL) (2pcs / 1bag)

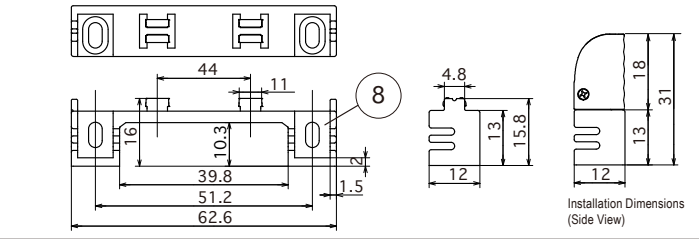

Spec • Rating may be subject to change without announcements

Unit Of Measure : mm

Part Name	Material	Note
1 Body	Aluminum, alumite treatment	White
2 Body Cover	Polycarbonate	Diffuser
3 Side cover	Polycarbonate	Diffuser
4 Lead wire		UL1007 AWG22, black+, white-
5 Connector	Nylon	5-1:SLP-02V(JST) White 5-2:SLR-02VF(JST) White
6 Magnet	Neodymium magnet	Silver
7 Mounting Clip	Polycarbonate	Clear
8 Mounting Clip (Lift clip)	Polycarbonate	Clear
9 Lead wire		UL1007 AWG20
10 Mounting Clip (Outer clip)	Polycarbonate	Clear

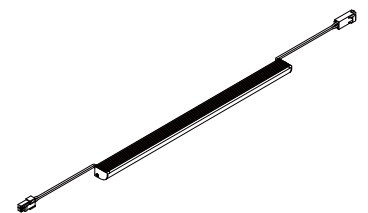

Spec	Item Number
Input voltage : DC24V Weight : 90g	LSXWK-0509-N-DF-I-13 LSXWK-0509-W-DF-I-13 LSXWK-0509-WW-DF-I-13 LSXWK-0509-L30-DF-I-13 LSXWK-0509-L27-DF-I-13 LSXWK-0509-L24-DF-I-13
Power consumption : 6.6W Number of LEDs : 98	
Max. sets connectable : 6m	
Environment : Indoors (No Condensation)	
Operating temperature : 0°C~+35°C (No Condensation)	
Accessories : Multiclip K (3pcs / 1 bag)	
Option parts : Power supply cable 3000mm,	
Joint cable 1000mm,	
Multiclip K (3pcs / 1 bag)	
Liftclip (2pcs / 1 bag)	
Outerclip (5pcs / 1 bag)	
Magnet attachment	
Light Source color :	
	Natural white : N : 5000K (405 lm*/ Ra 93)
	White : W : 4000K (405 lm*/ Ra 94)
	Warm white 3500K: WW : 3500K (388 lm*/ Ra 94)
	Warm white 3000K : L30 : 3000K (379 lm*/ Ra 93)
	Warm white 2700K : L27 : 2700K (362 lm/ Ra 93)
	Warm white 2400K : L24 : 2400K (336 lm*/ Ra 94)
	*=Equivalent

Job/Project Name	Area/Location/Circuit No.
Product Code	Qty. Length(mm)

**silux series**

**Luci silux wide K(13.3W/m)**

Luci silux wide K(13.3W/m) 573



Luci Pte. Ltd.

2020.04.10

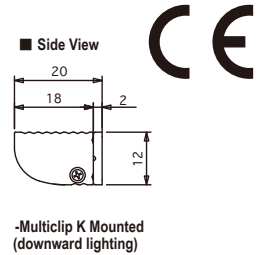
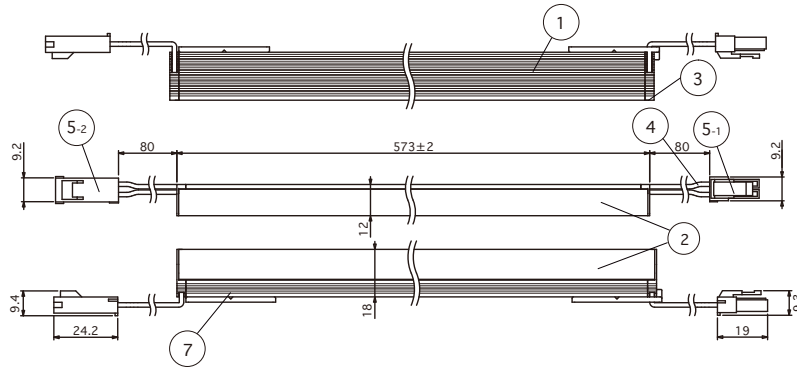

Installation Dimensions (Side View)

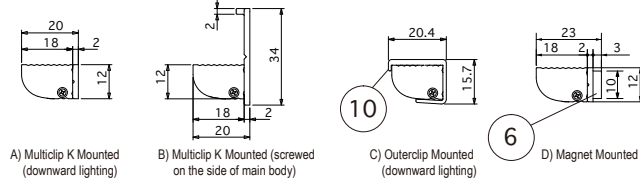

Accessories • Option parts :  
Multiclip K for silux (LSX-PTM-C) (3 or 5pcs / 1bag)

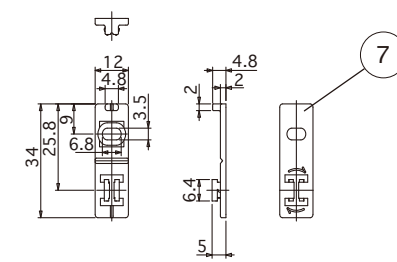

Option parts : Outerclip for silux wide (LSXW-PT-A) (5pcs / 1bag)

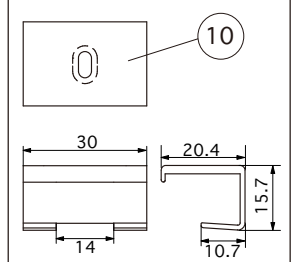

Option parts :  
Power supply cable 3000mm for SL connector (CAD-3000-MCRN-I)

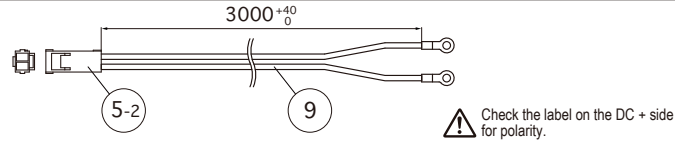

Option parts :  
Joint cable 1000mm for SL connector (CAD-1000-MCFC-I)

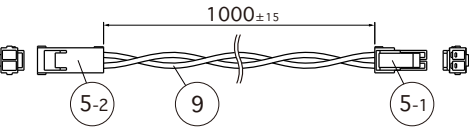

Option parts :  
Liftclip for silux (LSX-PTL) (2pcs / 1bag)

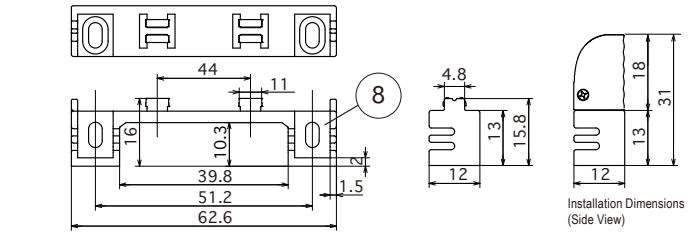

Spec · Rating may be subject to change without announcements

Unit Of Measure : mm

Part Name	Material	Note
1 Body	Aluminum, alumite treatment	White
2 Body Cover	Polycarbonate	Diffuser
3 Side cover	Polycarbonate	Diffuser
4 Lead wire		UL1007 AWG22, black+, white-
5 Connector	Nylon	5-1:SLP-02V(JST) White 5-2:SLR-02VF(JST) White
6 Magnet	Neodymium magnet	Silver
7 Mounting Clip	Polycarbonate	Clear
8 Mounting Clip (Lift clip)	Polycarbonate	Clear
9 Lead wire		UL1007 AWG20
10 Mounting Clip (Outer clip)	Polycarbonate	Clear

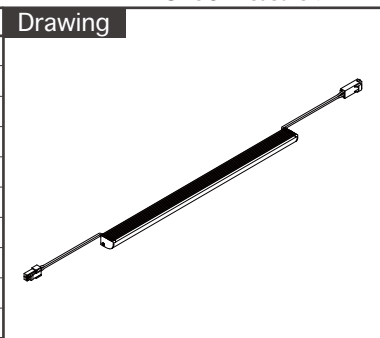

Spec	Input voltage : DC24V	Weight : 100g
Power consumption : 7.6W	Number of LEDs : 112	
Max. sets connectable : 6m		
Environment : Indoors (No Condensation)		
Operating temperature : 0°C~+35°C (No Condensation)		
Accessories : Multiclip K (3pcs / 1 bag)		
Option parts : Power supply cable 3000mm,		
Joint cable 1000mm,		
Multiclip K (3pcs / 1 bag)		
Liftclip (2pcs / 1 bag)		
Outerclip (5pcs / 1 bag)		
Magnet attachment		

Light Source color :	Item Number
Natural white : N : 5000K (456 lm*/ Ra 93)	LSXWK-0573-N-DF-I-13 LSXWK-0573-W-DF-I-13 LSXWK-0573-WW-DF-I-13 LSXWK-0573-L30-DF-I-13 LSXWK-0573-L27-DF-I-13 LSXWK-0573-L24-DF-I-13
White : W : 4000K (456 lm*/ Ra 94)	
Warm white 3500K: WW : 3500K (437 lm*/ Ra 94)	
Warm white 3000K : L30 : 3000K (427 lm*/ Ra 93)	
Warm white 2700K : L27 : 2700K (408 lm/ Ra 93)	
Warm white 2400K : L24 : 2400K (378 lm*/ Ra 94)	
*=Equivalent	

Job/Project Name	Area/Location/Circuit No.
Product Code	Qty. Length(mm)

**silux series**

**Luci silux wide K(13.3W/m)**

Luci silux wide K(13.3W/m) 702



**Luci Pte. Ltd.**

2020.04.10

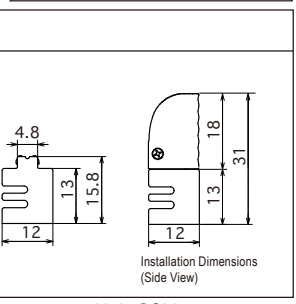
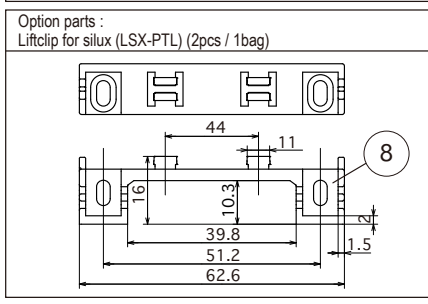
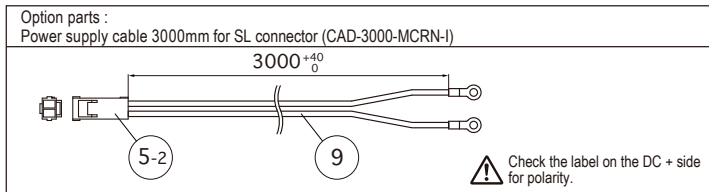
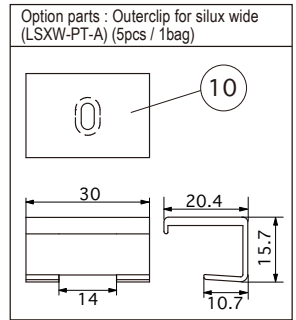
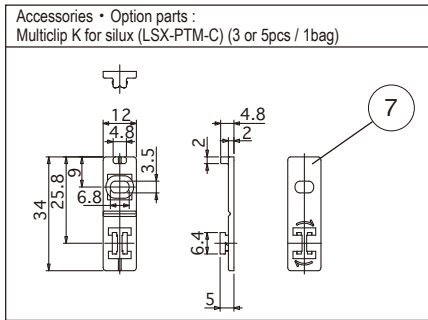
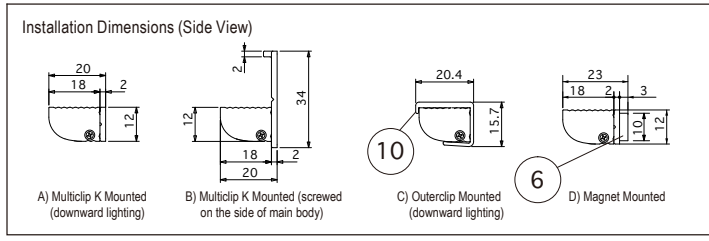
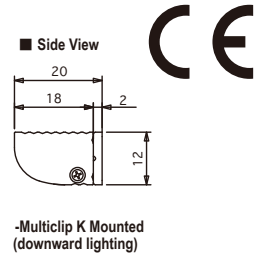
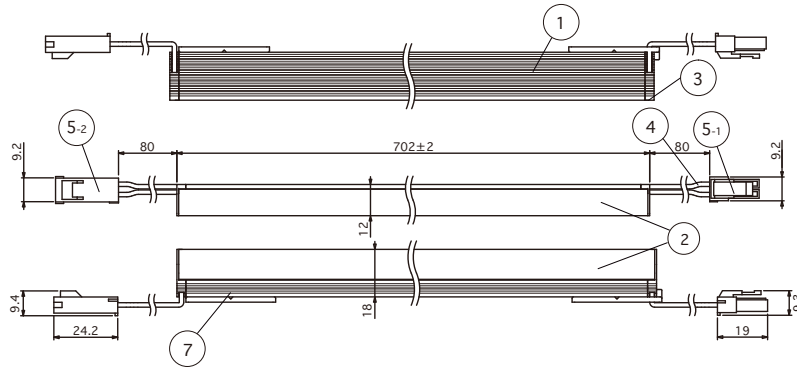

Spec · Rating may be subject to change without announcements

Unit Of Measure : mm

Part Name	Material	Note
1 Body	Aluminum, alumite treatment	White
2 Body Cover	Polycarbonate	Diffuser
3 Side cover	Polycarbonate	Diffuser
4 Lead wire		UL1007 AWG22, black+, white-
5 Connector	Nylon	5-1:SLP-02V(JST) White 5-2:SLR-02VF(JST) White
6 Magnet	Neodymium magnet	Silver
7 Mounting Clip	Polycarbonate	Clear
8 Mounting Clip (Lift clip)	Polycarbonate	Clear
9 Lead wire		UL1007 AWG20
10 Mounting Clip (Outer clip)	Polycarbonate	Clear

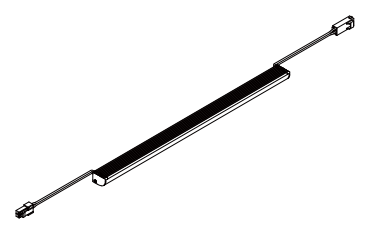

Spec	Input voltage : DC24V	Weight : 120g	Light Source color :
Power consumption : 9.5W	Number of LEDs : 140		Natural white : N : 5000K (558 lm* / Ra 94)
Max. sets connectable : 6m			White : W : 4000K (558 lm* / Ra 93)
Environment : Indoors (No Condensation)			Warm white 3500K: WW : 3500K (534 lm* / Ra 93)
Operating temperature : 0°C~+35°C (No Condensation)			Warm white 3000K: L30 : 3000K (522 lm* / Ra 94)
Accessories : Multiclip K (3pcs / 1 bag)			Warm white 2700K: L27 : 2700K (498 lm / Ra 94)
Option parts : Power supply cable 3000mm,			Warm white 2400K: L24 : 2400K (463 lm* / Ra 93)
Joint cable 1000mm,			
Multiclip K (3pcs / 1 bag)			
Liftclip (2pcs / 1 bag)			
Outerclip (5pcs / 1 bag)			
Magnet attachment			

Item Number
LSXWK-0702-N-DF-I-13
LSXWK-0702-W-DF-I-13
LSXWK-0702-WW-DF-I-13
LSXWK-0702-L30-DF-I-13
LSXWK-0702-L27-DF-I-13
LSXWK-0702-L24-DF-I-13

Job/Project Name \_\_\_\_\_ Area/Location/Circuit No. \_\_\_\_\_

Product Code \_\_\_\_\_ Qty. \_\_\_\_\_ Length(mm) \_\_\_\_\_



**silux series**

**Luci silux wide K(13.3W/m)**

Luci silux wide K(13.3W/m) 823



Luci Pte. Ltd.

2020.04.10

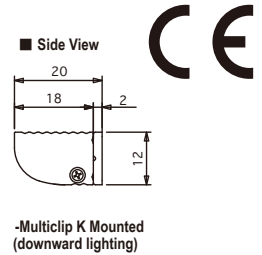
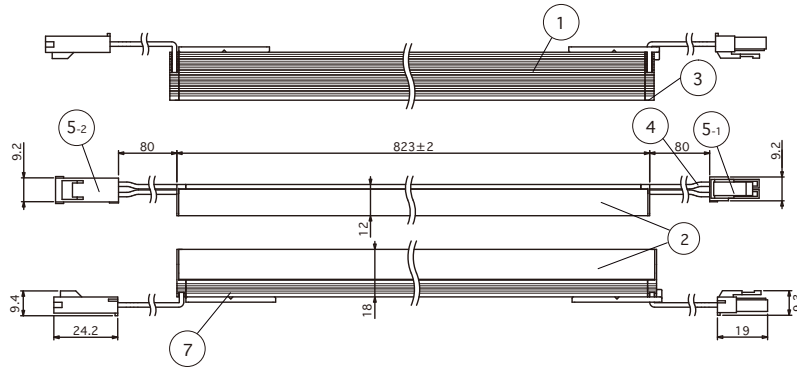

Installation Dimensions (Side View)

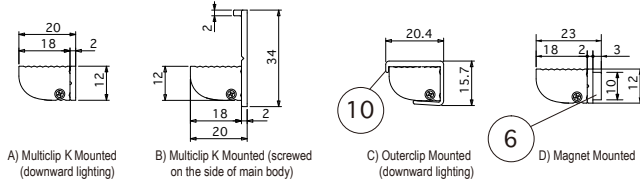

Accessories • Option parts :  
Multiclip K for silux (LSX-PTM-C) (3 or 5pcs / 1bag)

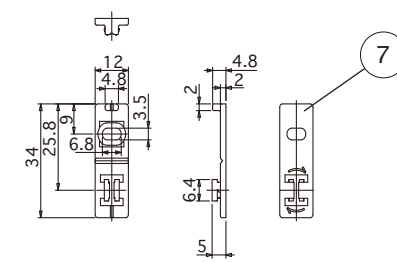

Option parts : Outerclip for silux wide (LSXW-PT-A) (5pcs / 1bag)

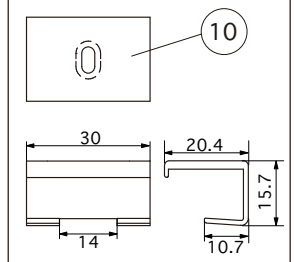

Option parts :  
Power supply cable 3000mm for SL connector (CAD-3000-MCRN-I)

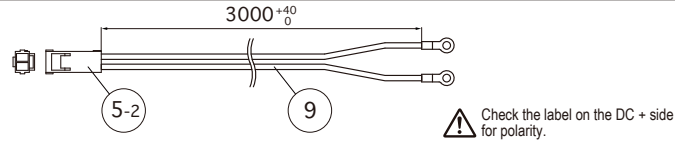

Option parts :  
Joint cable 1000mm for SL connector (CAD-1000-MCFC-I)

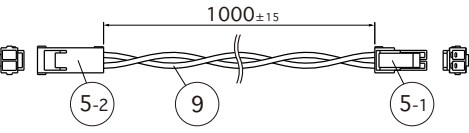

Option parts :  
Liftclip for silux (LSX-PTL) (2pcs / 1bag)

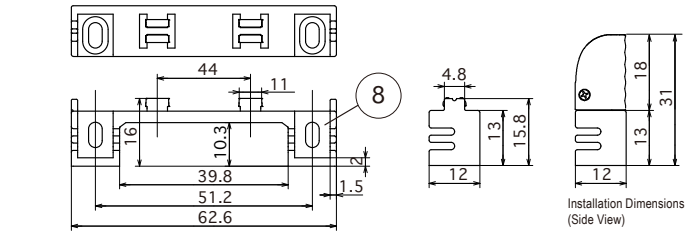

Spec · Rating may be subject to change without announcements

Unit Of Measure : mm

Part Name	Material	Note
1 Body	Aluminum, alumite treatment	White
2 Body Cover	Polycarbonate	Diffuser
3 Side cover	Polycarbonate	Diffuser
4 Lead wire		UL1007 AWG22, black+, white-
5 Connector	Nylon	5-1:SLP-02V(JST) White 5-2:SLR-02VF(JST) White
6 Magnet	Neodymium magnet	Silver
7 Mounting Clip	Polycarbonate	Clear
8 Mounting Clip (Lift clip)	Polycarbonate	Clear
9 Lead wire		UL1007 AWG20
10 Mounting Clip (Outer clip)	Polycarbonate	Clear

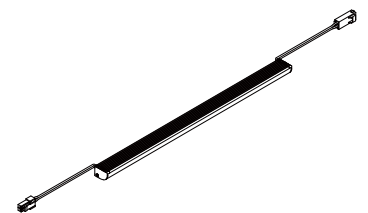

Spec	Input voltage : DC24V	Weight : 140g
Power consumption : 10.9W	Number of LEDs : 161	
Max. sets connectable : 6m		
Environment : Indoors (No Condensation)		
Operating temperature : 0°C~+35°C (No Condensation)		
Accessories : Multiclip K (5pcs / 1 bag)		
Option parts : Power supply cable 3000mm,		
Joint cable 1000mm,		
Multiclip K (3pcs / 1 bag)		
Liftclip (2pcs / 1 bag)		
Outerclip (5pcs / 1 bag)		
Magnet attachment		

Light Source color :	Item Number
Natural white : N : 5000K (659 lm*/ Ra 94)	LSXWK-0823-N-DF-I-13 LSXWK-0823-W-DF-I-13 LSXWK-0823-WW-DF-I-13 LSXWK-0823-L30-DF-I-13 LSXWK-0823-L27-DF-I-13 LSXWK-0823-L24-DF-I-13
White : W : 4000K (659 lm*/ Ra 93)	
Warm white 3500K: WW : 3500K (631 lm*/ Ra 93)	
Warm white 3000K : L30 : 3000K (617 lm*/ Ra 94)	
Warm white 2700K : L27 : 2700K (589 lm/ Ra 94)	
Warm white 2400K : L24 : 2400K (547 lm*/ Ra 93)	
*=Equivalent	

Job/Project Name	Area/Location/Circuit No.
Product Code	Qty. Length(mm)

**silux series**

**Luci silux wide K(13.3W/m)**

Luci silux wide K(13.3W/m) 1008



**Luci Pte. Ltd.**

2020.04.10

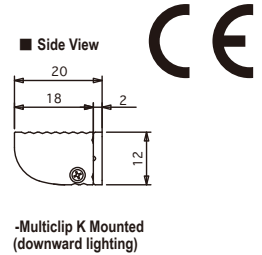
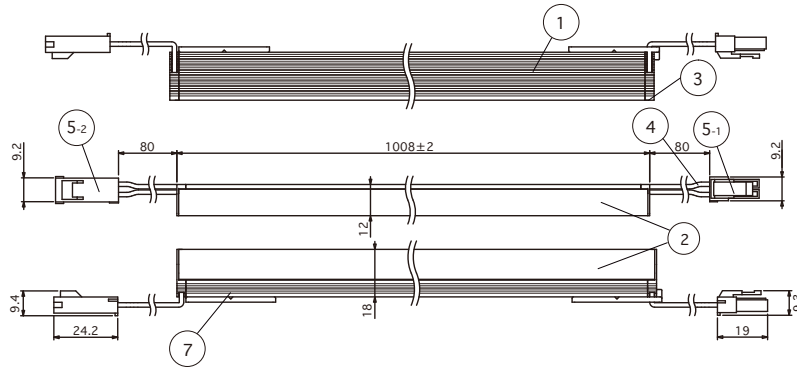

Installation Dimensions (Side View)

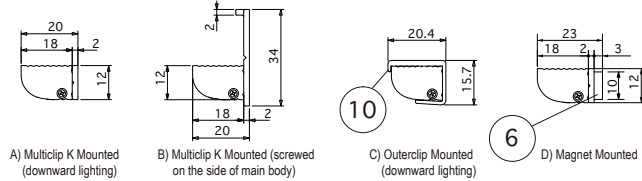

Accessories • Option parts :  
Multiclip K for silux (LSX-PTM-C) (3 or 5pcs / 1bag)

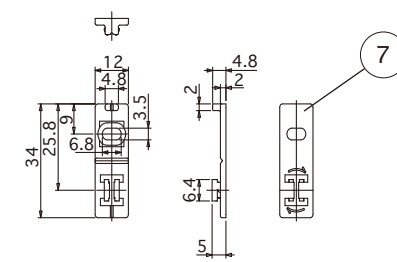

Option parts : Outerclip for silux wide (LSXW-PT-A) (5pcs / 1bag)

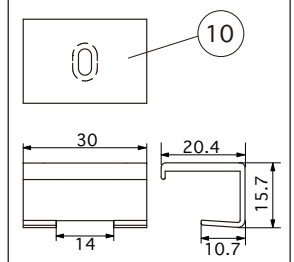

Option parts :  
Power supply cable 3000mm for SL connector (CAD-3000-MCRN-I)

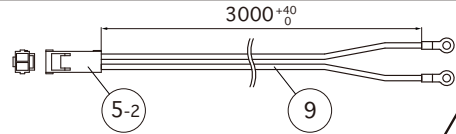

⚠ Check the label on the DC + side for polarity.

Option parts :  
Joint cable 1000mm for SL connector (CAD-1000-MCFC-I)

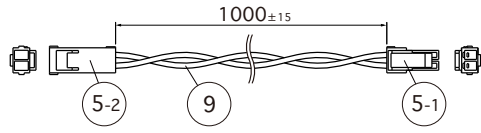

Option parts :  
Liftclip for silux (LSX-PTL) (2pcs / 1bag)

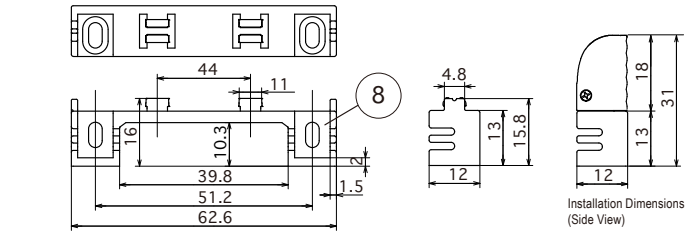

Spec • Rating may be subject to change without announcements

Unit Of Measure : mm

Part Name	Material	Note
1 Body	Aluminum, alumite treatment	White
2 Body Cover	Polycarbonate	Diffuser
3 Side cover	Polycarbonate	Diffuser
4 Lead wire		UL1007 AWG22, black+, white-
5 Connector	Nylon	5-1:SLP-02V(JST) White 5-2:SLR-02VF(JST) White
6 Magnet	Neodymium magnet	Silver
7 Mounting Clip	Polycarbonate	Clear
8 Mounting Clip (Lift clip)	Polycarbonate	Clear
9 Lead wire		UL1007 AWG20
10 Mounting Clip (Outer clip)	Polycarbonate	Clear

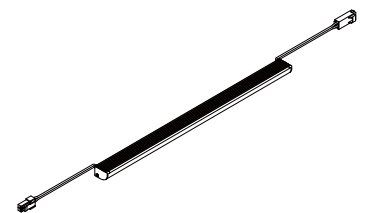

Spec	Input voltage : DC24V	Weight : 170g
Power consumption : 13.3W	Number of LEDs : 196	
Max. sets connectable : 6m		
Environment : Indoors (No Condensation)		
Operating temperature : 0°C~+35°C (No Condensation)		
Accessories : Multiclip K (5pcs / 1 bag)		
Option parts : Power supply cable 3000mm,		
Joint cable 1000mm,		
Multiclip K (3pcs / 1 bag)		
Liftclip (2pcs / 1 bag)		
Outerclip (5pcs / 1 bag)		
Magnet attachment		

Light Source color :	Item Number
Natural white : N : 5000K (811 lm* / Ra 93)	LSXWK-1008-N-DF-I-13 LSXWK-1008-W-DF-I-13 LSXWK-1008-WW-DF-I-13 LSXWK-1008-L30-DF-I-13 LSXWK-1008-L27-DF-I-13 LSXWK-1008-L24-DF-I-13
White : W : 4000K (811 lm* / Ra 94)	
Warm white 3500K: WW : 3500K (777 lm* / Ra 94)	
Warm white 3000K : L30 : 3000K (759 lm* / Ra 93)	
Warm white 2700K : L27 : 2700K (725 lm / Ra 93)	
Warm white 2400K : L24 : 2400K (673 lm* / Ra 94)	
*=Equivalent	

Job/Project Name	Area/Location/Circuit No.
Product Code	Qty. Length(mm)



**silux series**

**Luci silux wide K(13.3W/m)**

Luci silux wide K(13.3W/m) 1137



**Luci Pte. Ltd.**

2020.04.10

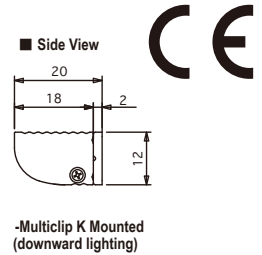
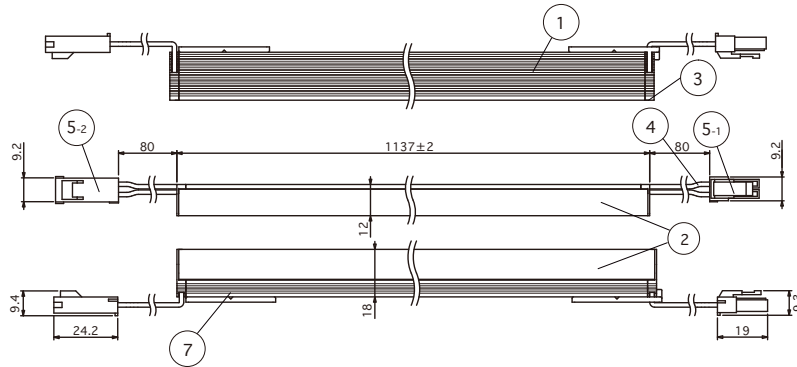

**Installation Dimensions (Side View)**

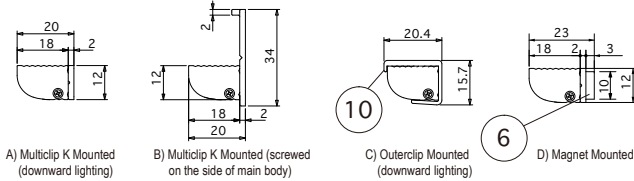

**Accessories • Option parts :**  
Multiclip K for silux (LSX-PTM-C) (3 or 5pcs / 1bag)

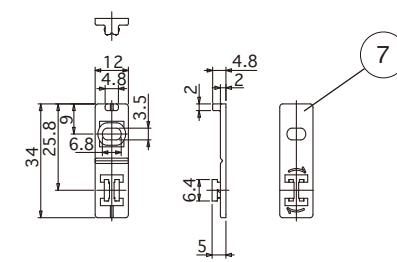

**Option parts : Outerclip for silux wide (LSXW-PT-A) (5pcs / 1bag)**

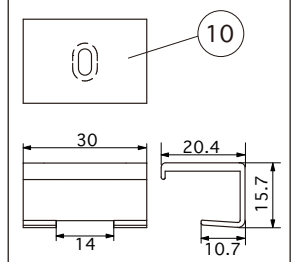

**Option parts :**  
Power supply cable 3000mm for SL connector (CAD-3000-MCRN-I)

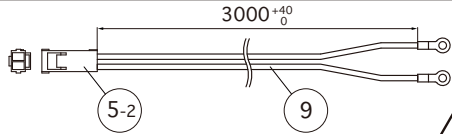

⚠ Check the label on the DC + side for polarity.

**Option parts :**  
Joint cable 1000mm for SL connector (CAD-1000-MCFC-I)

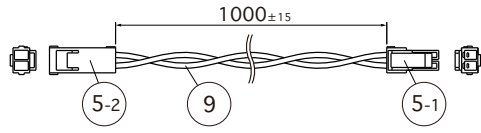

**Option parts :**  
Liftclip for silux (LSX-PTL) (2pcs / 1bag)

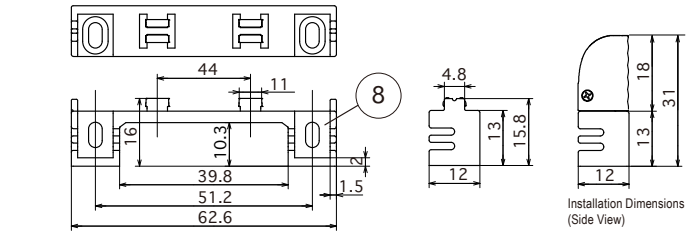

Spec · Rating may be subject to change without announcements

Unit Of Measure : mm

Part Name	Material	Note
1 Body	Aluminum, alumite treatment	White
2 Body Cover	Polycarbonate	Diffuser
3 Side cover	Polycarbonate	Diffuser
4 Lead wire		UL1007 AWG22, black+, white-
5 Connector	Nylon	5-1:SLP-02V(JST) White 5-2:SLR-02VF(JST) White
6 Magnet	Neodymium magnet	Silver
7 Mounting Clip	Polycarbonate	Clear
8 Mounting Clip (Lift clip)	Polycarbonate	Clear
9 Lead wire		UL1007 AWG20
10 Mounting Clip (Outer clip)	Polycarbonate	Clear

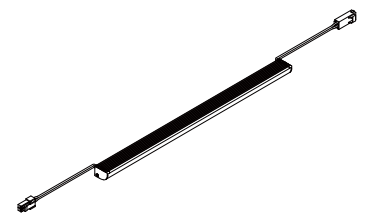

Spec	Input voltage : DC24V	Weight : 192g
Power consumption : 15.2W	Number of LEDs : 224	
Max. sets connectable : 6m		
Environment : Indoors (No Condensation)		
Operating temperature : 0°C~+35°C (No Condensation)		
Accessories : Multiclip K (5pcs / 1 bag)		
Option parts : Power supply cable 3000mm,		
Joint cable 1000mm,		
Multiclip K (3pcs / 1 bag)		
Liftclip (2pcs / 1 bag)		
Outerclip (5pcs / 1 bag)		
Magnet attachment		

Light Source color :	Item Number
Natural white : N : 5000K (913 lm* / Ra 93)	LSXWK-1137-N-DF-I-13 LSXWK-1137-W-DF-I-13 LSXWK-1137-WW-DF-I-13 LSXWK-1137-L30-DF-I-13 LSXWK-1137-L27-DF-I-13 LSXWK-1137-L24-DF-I-13
White : W : 4000K (913 lm* / Ra 94)	
Warm white 3500K: WW : 3500K (874 lm* / Ra 94)	
Warm white 3000K : L30 : 3000K (854 lm* / Ra 93)	
Warm white 2700K : L27 : 2700K (816 lm / Ra 93)	
Warm white 2400K : L24 : 2400K (757 lm* / Ra 94)	
*=Equivalent	

Job/Project Name	Area/Location/Circuit No.
Product Code	Qty. Length(mm)

**silux series**

**Luci silux wide K(13.3W/m)**

Luci silux wide K(13.3W/m) 1451



**Luci Pte. Ltd.**

2020.04.10

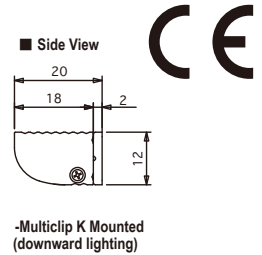
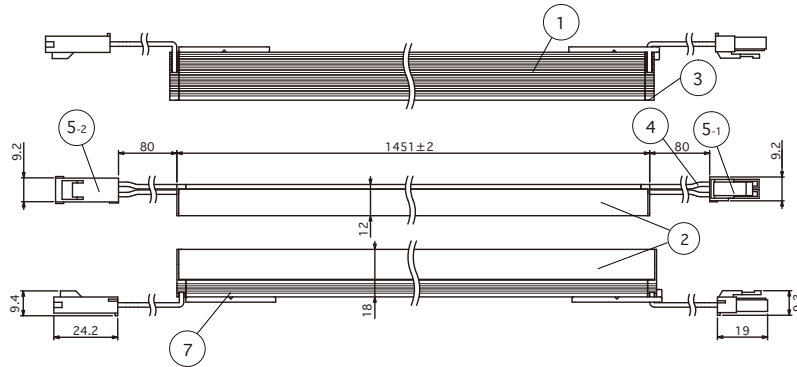

Installation Dimensions (Side View)

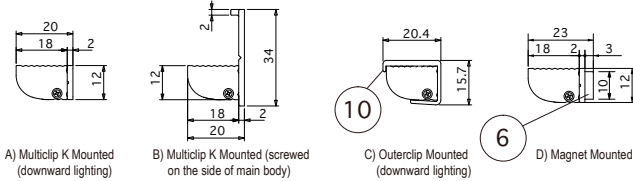

Accessories • Option parts :  
Multiclip K for silux (LSX-PTM-C) (3 or 5pcs / 1bag)

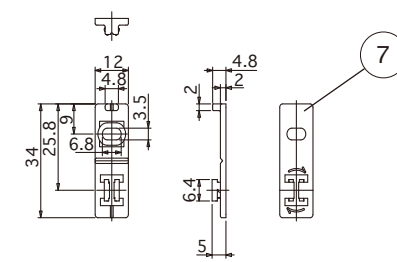

Option parts : Outerclip for silux wide (LSXW-PT-A) (5pcs / 1bag)

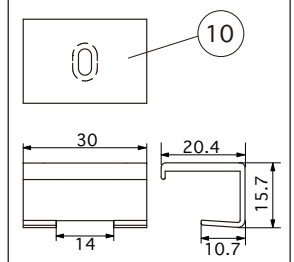

Option parts :  
Power supply cable 3000mm for SL connector (CAD-3000-MCRN-I)

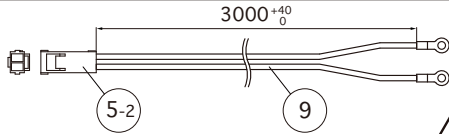

⚠ Check the label on the DC + side for polarity.

Option parts :  
Joint cable 1000mm for SL connector (CAD-1000-MCFC-I)

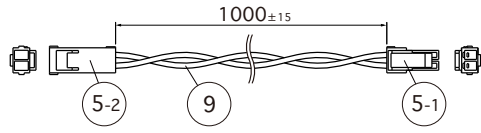

Option parts :  
Liftclip for silux (LSX-PTL) (2pcs / 1bag)

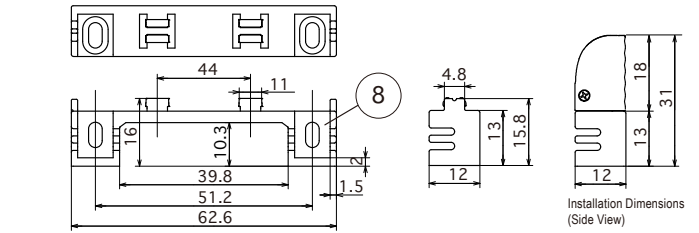

Spec · Rating may be subject to change without announcements

Unit Of Measure : mm

Part Name	Material	Note
1 Body	Aluminum, alumite treatment	White
2 Body Cover	Polycarbonate	Diffuser
3 Side cover	Polycarbonate	Diffuser
4 Lead wire		UL1007 AWG22, black+, white-
5 Connector	Nylon	5-1:SLP-02V(JST) White 5-2:SLR-02VF(JST) White
6 Magnet	Neodymium magnet	Silver
7 Mounting Clip	Polycarbonate	Clear
8 Mounting Clip (Lift clip)	Polycarbonate	Clear
9 Lead wire		UL1007 AWG20
10 Mounting Clip (Outer clip)	Polycarbonate	Clear

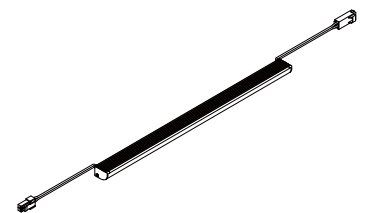

Spec	Input voltage : DC24V	Weight : 240g
Power consumption : 19.5W	Number of LEDs : 287	
Max. sets connectable : 6m		
Environment : Indoors (No Condensation)		
Operating temperature : 0°C~+35°C (No Condensation)		
Accessories : Multiclip K (5pcs / 1 bag)		
Option parts : Power supply cable 3000mm,		
Joint cable 1000mm,		
Multiclip K (3pcs / 1 bag)		
Liftclip (2pcs / 1 bag)		
Outerclip (5pcs / 1 bag)		
Magnet attachment		

Light Source color :	Item Number
Natural white : N : 5000K (1175 lm* / Ra 93)	LSXWK-1451-N-DF-I-13 LSXWK-1451-W-DF-I-13 LSXWK-1451-WW-DF-I-13 LSXWK-1451-L30-DF-I-13 LSXWK-1451-L27-DF-I-13 LSXWK-1451-L24-DF-I-13
White : W : 4000K (1125 lm* / Ra 94)	
Warm white 3500K: WW : 3500K (1079 lm* / Ra 94)	
Warm white 3000K : L30 : 3000K (1029 lm* / Ra 93)	
Warm white 2700K : L27 : 2700K (974 lm / Ra 93)	
Warm white 2400K : L24 : 2400K (976 lm* / Ra 94)	
*=Equivalent	

Job/Project Name	Area/Location/Circuit No.
Product Code	Qty. Length(mm)